

Submittal Data Sheet Booklet

Range: Wilo-Stratos

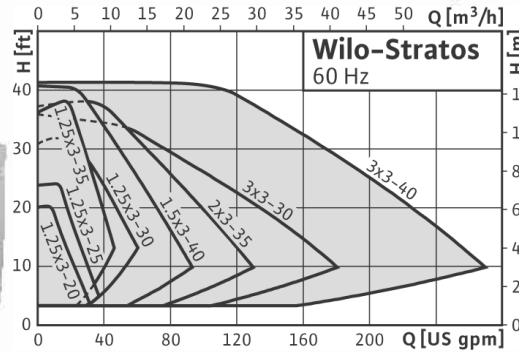

> Single head pumps:

- Electronically controlled circulating pumps with flanged connection

> Applications:

- Hot-water heating systems of all kinds, air conditioning, closed cooling circuits, industrial circulating systems

> Special features:

- ECM-Technology for outstanding efficiency
- Cataphoresis coating for preventing corrosion in the event of condensation
- Maintenance free single-head circulator
- Automatically air venting

> Product advantages:

- Energy savings up to 80% over standard pumps
- For all heating, air-conditioning and cooling systems in the temperature range of 14 °F (-10 °C) to 230 °F (+110 °C)
- Optimal handling through frontal operation and frontal access to the terminal room (face to face)
- Variable installation positions
- Reliability and comfort during installation



WILO Stratos Submittal

Stratos 1.25 x 3-25



Pumpen Intelligenz.

Project:	
Engineer:	
Contractor:	
Submitted By:	Date:
Approved By:	Date:

Tag #	Model #	Flow	Head	Volt/Phase	Control	IF Module	Comments
	Stratos 1.25 x 3-25			230/1/60			

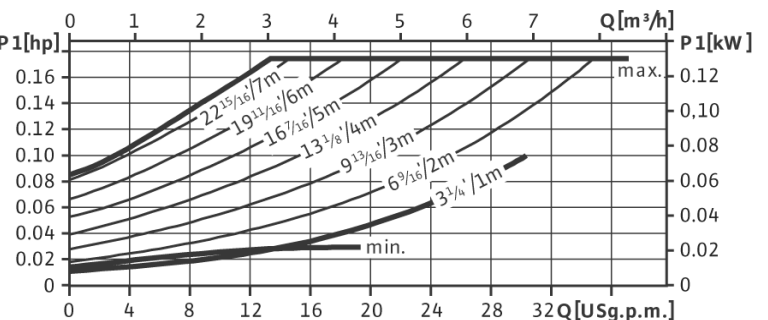
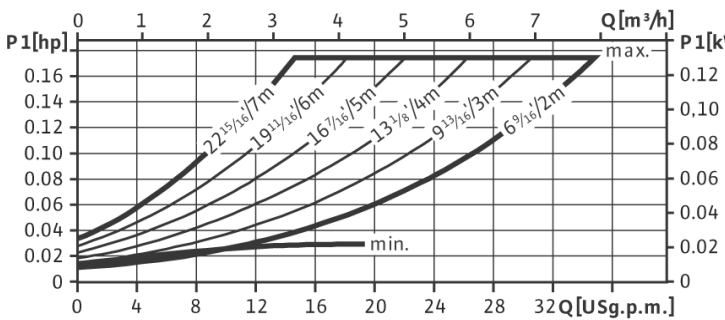
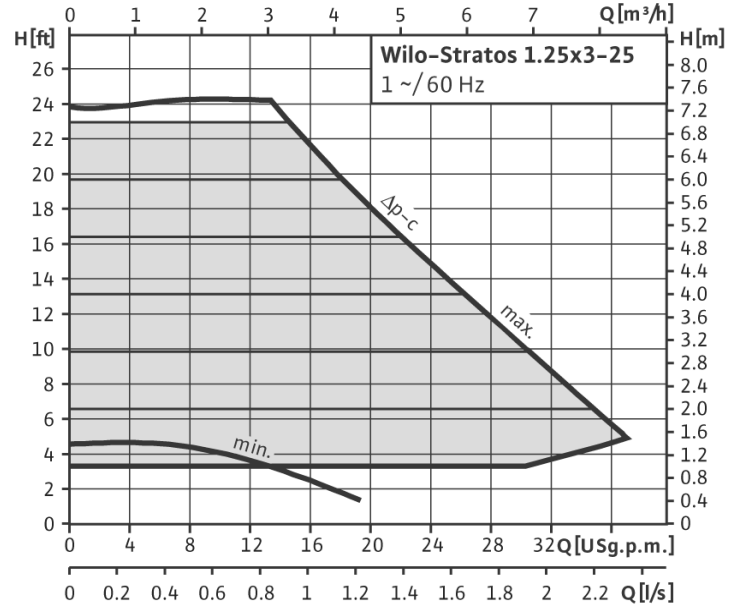
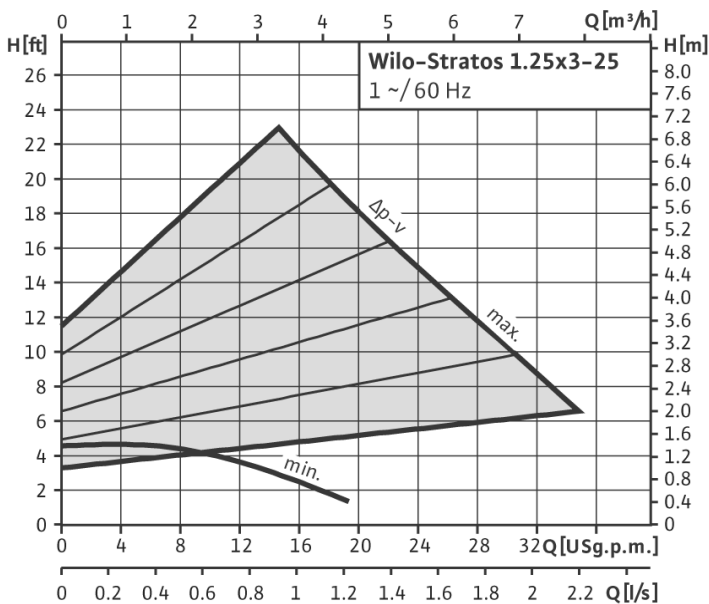

Control Modes

- p-v Pressure Differential Variable - factory default setting (set pressure is half at zero flow)
- p-c Pressure Differential Constant (set pressure constant)
- p-t Temperature Influenced Differential Pressure Control (IR Device Required to Activate)
- Automatic Night Set Back Activated - factory default setting
- Manual Speed Control (RPM x 100)

IF Interface Modules (optional)

- External Min/0 to 10 Volt DC (0 - 10 Vdc input remotely controls headset point or pump speed)/DP (Dual Pump)
 - External Min (control override) remote, volt free n/c contact
- External Off/OC (Operation Contact)/DP (Dual Pump)
 - External Off (control override) remote, volt free n/c contact,
 - Operation Contact, volt free n/o contact
- LON/DP (LonWorks BMS communication and Dual Pump)



WILO Stratos Submittal

Stratos 1.25 x 3-25



Pumpen Intelligenz.

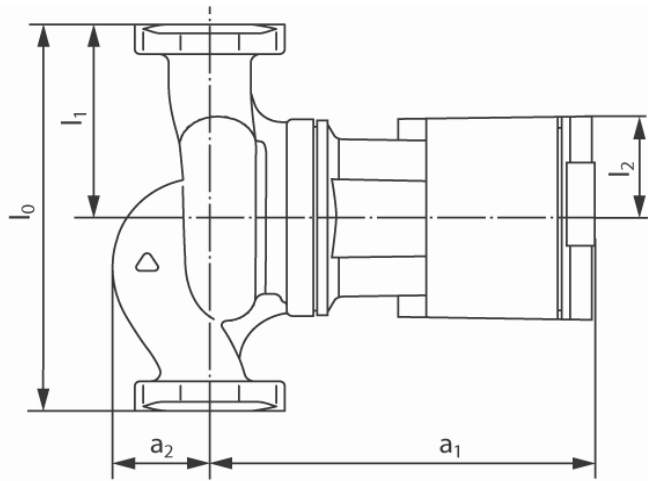
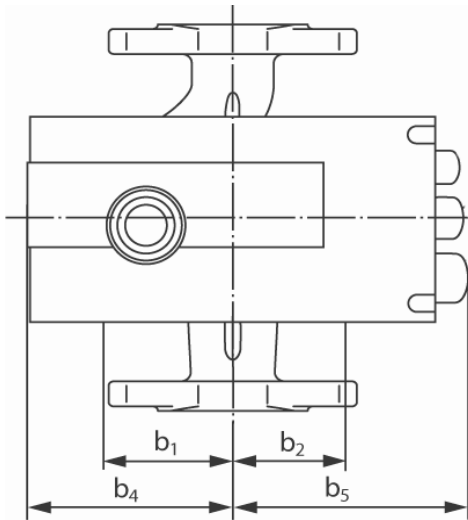

Pump Dimensions

Details	Max Hp	Pipe Size	l ₀	l ₁	l ₂	a ₁	a ₂	b ₁	b ₂	b ₄	b ₅	Weight
Imperial	1/8 Hp	1 1/4"	6 1/2	3 1/4	1 7/8	7 1/8	1 11/16	2 1/8	1 7/8	3 9/16	4 1/2	9.3 lbs
Metric	100 Watt	40 mm	165	82.5	49	182	43	54	47.5	90	114	4.2 kg

Flange Dimensions

Details	Flange	D	d1 (dia)	d2	k (dia)	n x dL
Imperial	1 1/4	4 3/4	1 3/8	2 7/8	3 1/2	2 x 1/2
Metric	32 mm	121	35	73	89	2 x 14

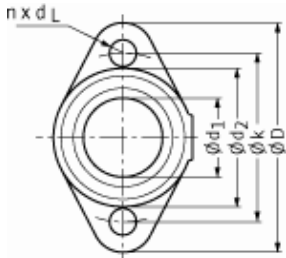

Electrical Information

Rated Power (P2) Hp max	Rated Power (P2) Watts max	Speed Range	Consumed Power (P1) watts min/max	Amps 230/1 (and 230/3)	Motor Protection
0.134	100	1400 - 3700	9 - 130	0.13 - 1.20	Integrated

Minimum Inlet Pressure

122 deg F (50 C)	203 deg F (95 C)	230 deg F (110 C)
4.4 PSI	14.5 PSI	23.2 PSI

Operating Limits

Temp Min/Max 14 to 230 Deg F (- 10 to +110 Deg C)
 Max Ambient Temp 104 Deg F (40 Deg C)
 Max Working Press 145 PSI (10 Bar)

Materials of Construction

Impeller Fibreglass Reinforced PPS
 Shaft Stainless Steel (X46 Cr13)
 Bearing Metal Impregnated Carbon
 Volute Cast Iron, Cataphoresis Coated

Motor/Electronics

Power Electronics Frequency Converter - ECM Type
 Degree of Protection Enclosure 2
 Insulation Class H

