

Description	Value
Product name:	UPS 26-99 BFC
Product Number:	52722519
EAN number:	5700834891045
Technical:	
Speed Number:	3
Max flow:	33 US gpm
Head max:	28.9 ft
Approvals on nameplate:	UL, CSA
Valve:	pump with built-in isolating and non-return valves
Materials:	
Pump housing:	Bronze
	DIN W.-Nr. 2.1176.01
Impeller:	Composite, PES
Installation:	
Maximum ambient temperature:	104 °F
Ambient max at 176°F liquid	176 °F
Maximum operating pressure	145 psi
Flange standard:	USA Oval
Type of connection:	Bronze Flange
Pipe connection:	2 - Bolt Flange
Pressure stage:	10
Port-to-port length:	6 1/2 in
Liquid:	
Liquid temperature range	35.6 .. 230 °F
Density:	62.4 lb/ft ³
Electrical data:	
Number of poles:	2
Power input in speed 1:	150 W
Power input in speed 2:	179 W
Max. power input:	196 W
Rated power - P2:	0.161 HP
Main frequency:	60 Hz
Rated voltage:	1 x 230 V
Current in speed 1	0.7 A
Current in speed 2	0.8 A
Current in speed 3	0.9 A
Capacitor size - run	5 µF/400 V
Insulation class (IEC 85):	F
Motor protection:	CONTACT
Thermal protec:	internal
Controls:	
Pos term box:	9H
Others:	
Gross weight:	10.3 lb

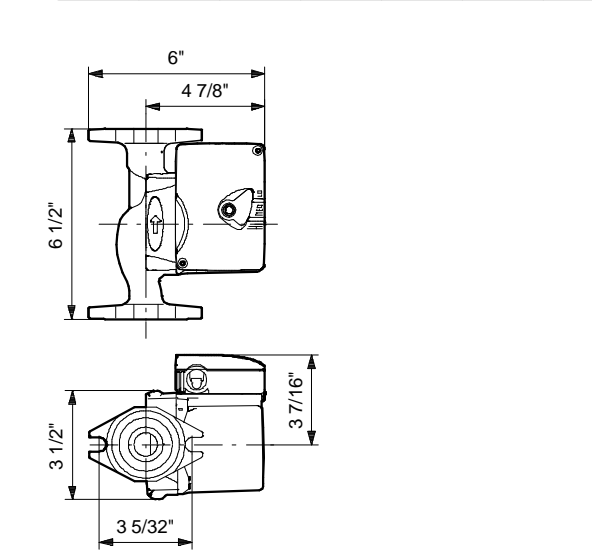

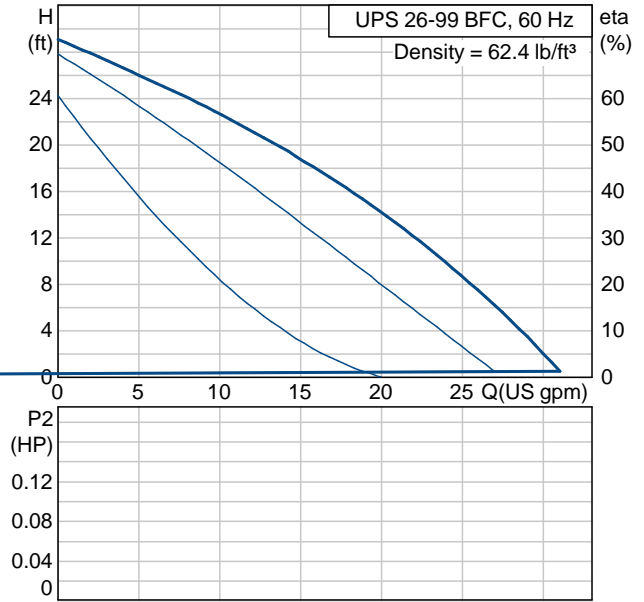
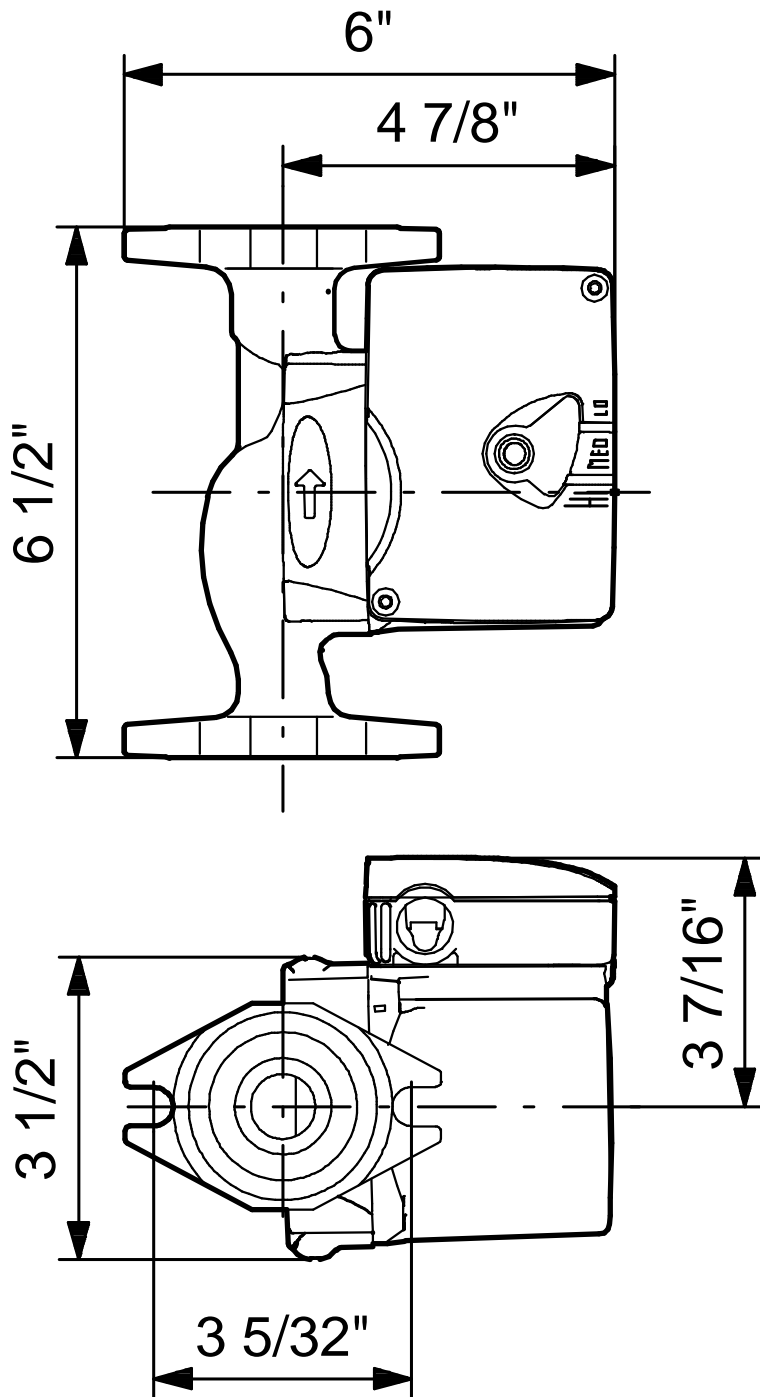

Note! All units are in [mm] unless others are stated.
Disclaimer: This simplified dimensional drawing does not show all details.