

Description	Value
Product name:	UPS 43-44 FC
Product Number:	52722514
EAN number:	5700834818721
Technical:	
Speed Number:	3
Max flow:	63 US gpm
Head max:	14.1 ft
Approvals on nameplate:	UL, CSA
Valve:	pump with built-in isolating and non-return valves
Materials:	
Pump housing:	Cast iron EN-JL1030 ASTM 30 B
Impeller:	Composite, PES
Installation:	
Maximum ambient temperature:	104 °F
Ambient max at 176°F liquid	176 °F
Maximum operating pressure	145 psi
Flange standard:	USA Oval
Type of connection:	C.I. Flange
Pipe connection:	2 - Bolt Flange
Pressure stage:	10
Port-to-port length:	8 1/2 in
Liquid:	
Liquid temperature range	35.6 .. 230 °F
Density:	62.4 lb/ft ³
Electrical data:	
Number of poles:	2
Power input in speed 1:	157 W
Power input in speed 2:	189 W
Max. power input:	203 W
Rated power - P2:	0.161 HP
Main frequency:	60 Hz
Rated voltage:	1 x 115 V
Current in speed 1	1.4 A
Current in speed 2	1.7 A
Current in speed 3	1.8 A
Capacitor size - run	20 µF/180 V
Insulation class (IEC 85):	F
Motor protection:	CONTACT
Thermal protec:	internal
Controls:	
Pos term box:	9H
Others:	
Gross weight:	13.5 lb

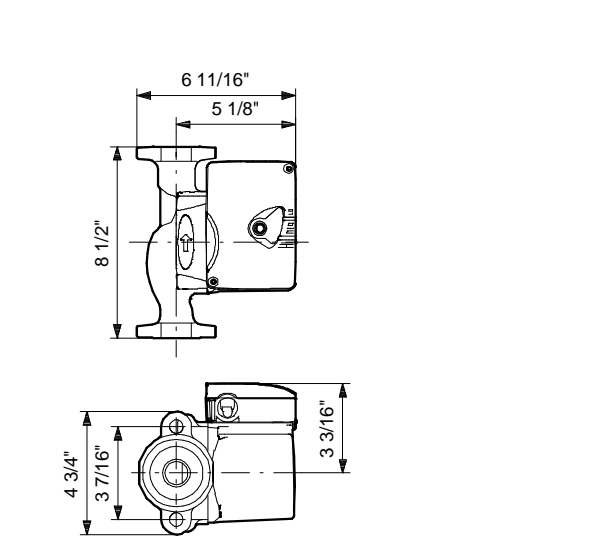

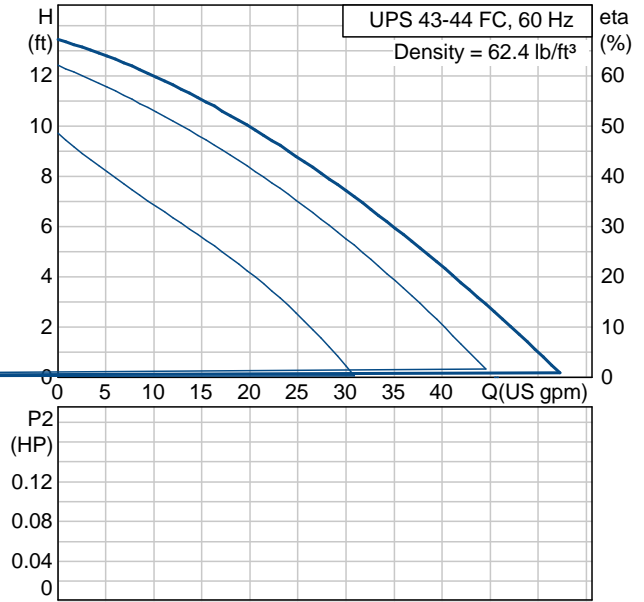
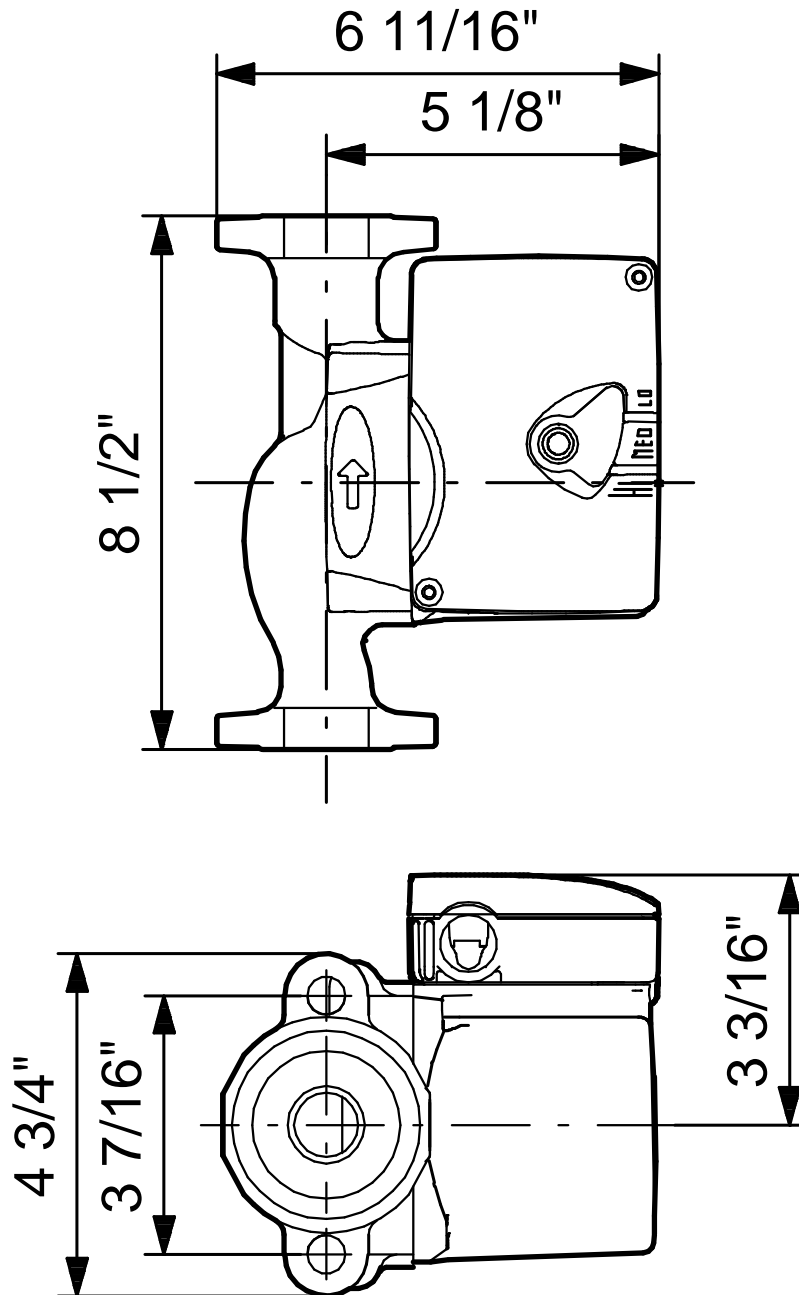

Note! All units are in [mm] unless others are stated.
Disclaimer: This simplified dimensional drawing does not show all details.